

## 5.4. Some Approximate models

To obtain a specific values of  $E$  and  $\psi$ , one needs to solve Schrodinger equation for the *actual potential*  $V(r)$  in the solid of interest. But since this is a very tough task, it is preferable to solve Schrodinger equation using some simplified potentials.

### Empty-lattice model:

\* In this simplest case the crystal potential is assumed to be exactly zero ;  $V(r)=0$ .

i.e. the electron is completely free.

\* For 1D; the state functions and energies are:

$$\psi_k^0 = \frac{1}{L^{1/2}} e^{ik.x} \quad (6)$$

and

$$E_k^0 = \frac{\hbar^2 k^2}{2m^*} \quad (7)$$

where  $L = Na$  is the length a long x axis and the superscript **0** indicates that these solutions obtained at  $V(x)=0$ .

\* According to eq. (7) the dispersion curve of electrons has the familiar *parabolic* shape shown in **Fig.a** .

**The extended-zone scheme**

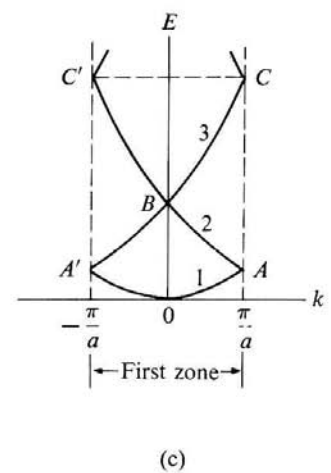
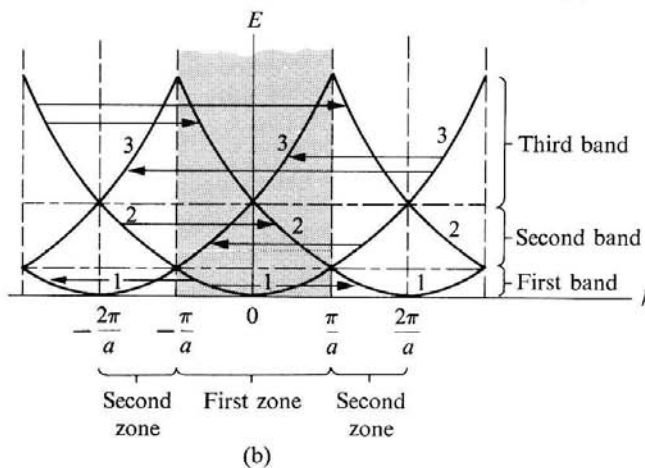
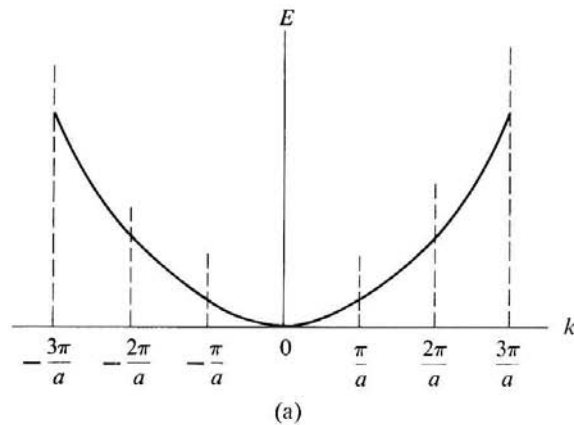

**The periodic-zone scheme**

**The reduced-zone scheme**

**Nearly-free-electron model (NFE):**

- \* In this model the crystal potential is assumed to be so weak ; i.e. the electron is nearly free.
- \* This model can serve as a rough approximation to the valence bands in the simple metals such as: Na, K, Al, etc.
- \* On the basis of *perturbation method* one finds that the crystal potential will only affect the regions near the zone boundaries. This effect is to smooth over the sharp corners, and hence, to create energy gaps at these regions with values of,

$$E_{g,n} = 2|V_{-n2\pi/a}|$$

where  $V_{-2\pi/a}$  is the Fourier component of the potential, that is,

$$V_{-2\pi/a} = \frac{1}{L} \int V(x) e^{i(2\pi/a)x} dx$$

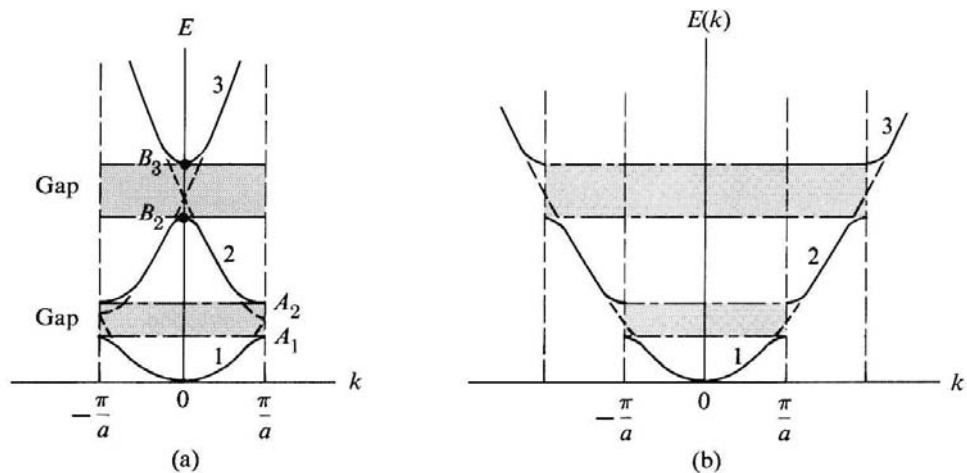

- \* Physically, **energy gaps** can be explained according to **Bragg reflection** of electron waves in crystal:
- 1- When Bragg condition  $k = \pm n\pi/a$  is satisfied at the zone boundaries, a wave traveling to the right is Bragg reflected to the left forming a *standing wave*.
  - 2- Two different standing waves  $\psi(+)$  &  $\psi(-)$  will be formed from the two traveling waves  $e^{ikr}$  &  $e^{-ikr}$ .
  - 3- Each of these standing wave will pile up electrons at two different directions for the same  $k$ , and this the origin of the energy gap.

## tight-binding model (TB):

- \* In this model the crystal potential is assumed to be strong so that the electron is captured by ions for some intervals. During each interval the electron orbits around a single ion, i.e. its state function is that of an atomic orbital.
- \* This model can serve as a rough approximation to the narrow, inner bands in solids.

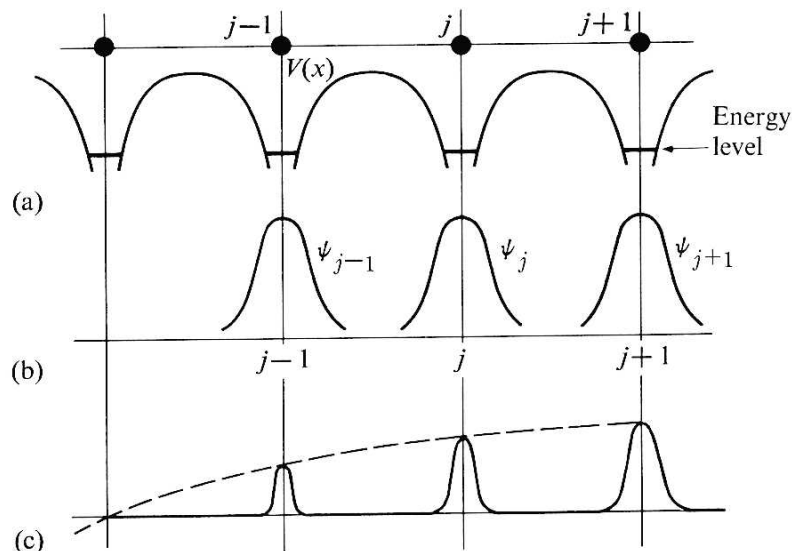

## 5.5. Metals, Insulators & Semiconductors

- \* The fact that used to distinguish between these types of solids is:

*A band which is completely full carries no electric current, even in the presence of an electric field.*

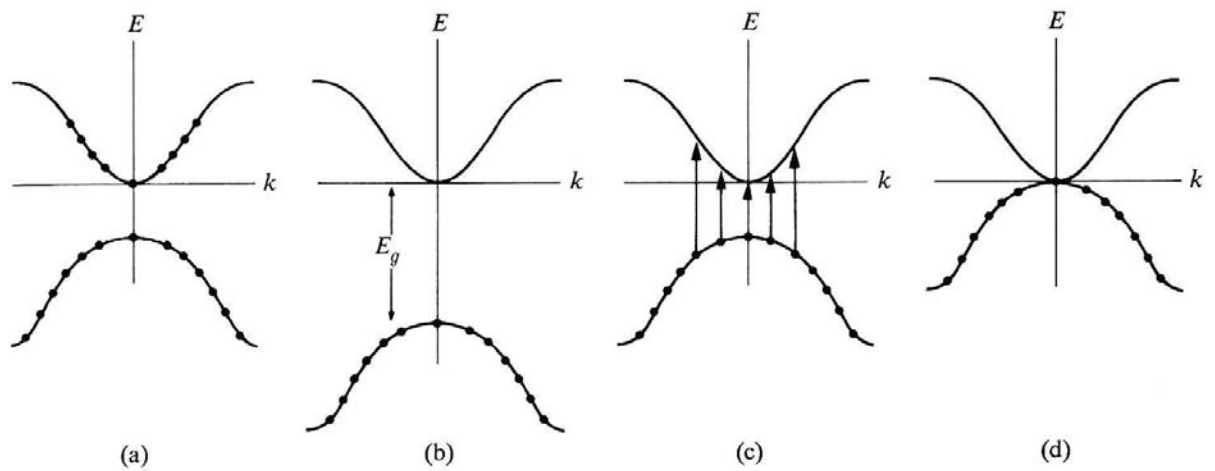

\* If the gap between the valance band and the band immediately above it is small, electrons may be thermally excited across the gap and the solid is called a *semiconductor*.

\* At room temperature a substance behaves as a semiconductor if  $E_g$  is less than  $2\text{eV}$ .

\* In insulators  $E_g \sim 7\text{eV}$ .

## 5.6. Electron Density of states

Let  $g(E)$  defines the electron density of states, i.e.

$g(E) dE$  = number of electron states per unit volume in the energy range  $(E - E+dE)$ .

For regions near the zone center:

- Dispersion relation is given by;

$$E_k = \frac{\hbar^2 k^2}{2m^*} \quad (7)$$

- The corresponding energy contours in k-space are spheres surrounding the origin.
- Volume of shell confined between  $E$  &  $E+dE$  is:

$$4\pi k^2 dk$$

Hence:

$$\begin{aligned} g(E)dE &= \frac{V}{(2\pi)^3} \\ &= \frac{1}{(2\pi)^3} 4\pi k^2 dk \\ &= \frac{1}{4\pi^2} \left( \frac{2m^*}{\hbar^2} \right)^{3/2} E^{1/2} dE \end{aligned}$$

Or,

$$g(E) = \frac{1}{4\pi^2} \left( \frac{2m^*}{\hbar^2} \right)^{3/2} E^{1/2}$$

Taking into account the spin degeneracy leads to

$$g(E) = \frac{1}{2\pi^2} \left( \frac{2m^*}{\hbar^2} \right)^{3/2} E^{1/2} \quad (8)$$

Note:

- \* The larger the energy the greater the radius, and hence the larger the number of states.
- \* The greater the mass the larger the number of states.

For regions near the zone boundaries:

- Dispersion relation given by (7) is not valid.
- As a result the density of states will have a more complicated formula. The following Fig. shows how  $g(E)$  will vary with  $E$  near the zone boundaries.

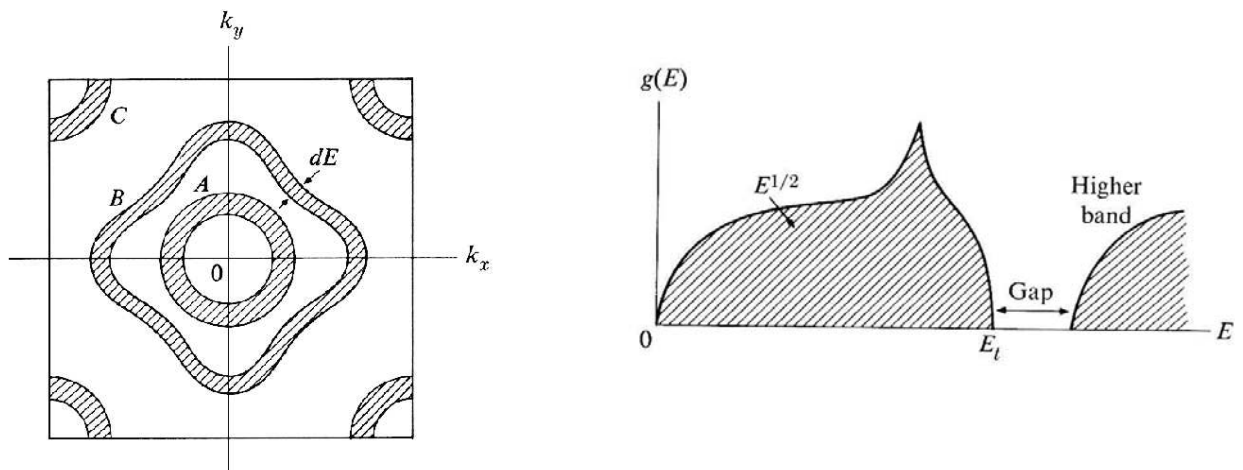

## 5.7 The Fermi Surface

**Recall:**  $FS$  is the surface in k-space inside which all states are occupied by valence electrons.

**Or:**  $FS$  is the surface in k-space below which all states are occupied and all states above it are empty.

\* We will determine the Fermi energy  $E_F$  in the regions where the relation (7) is applicable.  
From definition;

$$\int_0^{E_F} g(E)dE = n \quad (9)$$

Using (8) & (9) we get;

$$E_F = \frac{\hbar^2}{2m^*} (3\pi^2 n)^{2/3}$$

Or

$$E_F = \frac{\hbar^2 k_F^2}{2m^*} \quad (10)$$

Where

$$k_F = (3\pi^2 n)^{1/3}$$



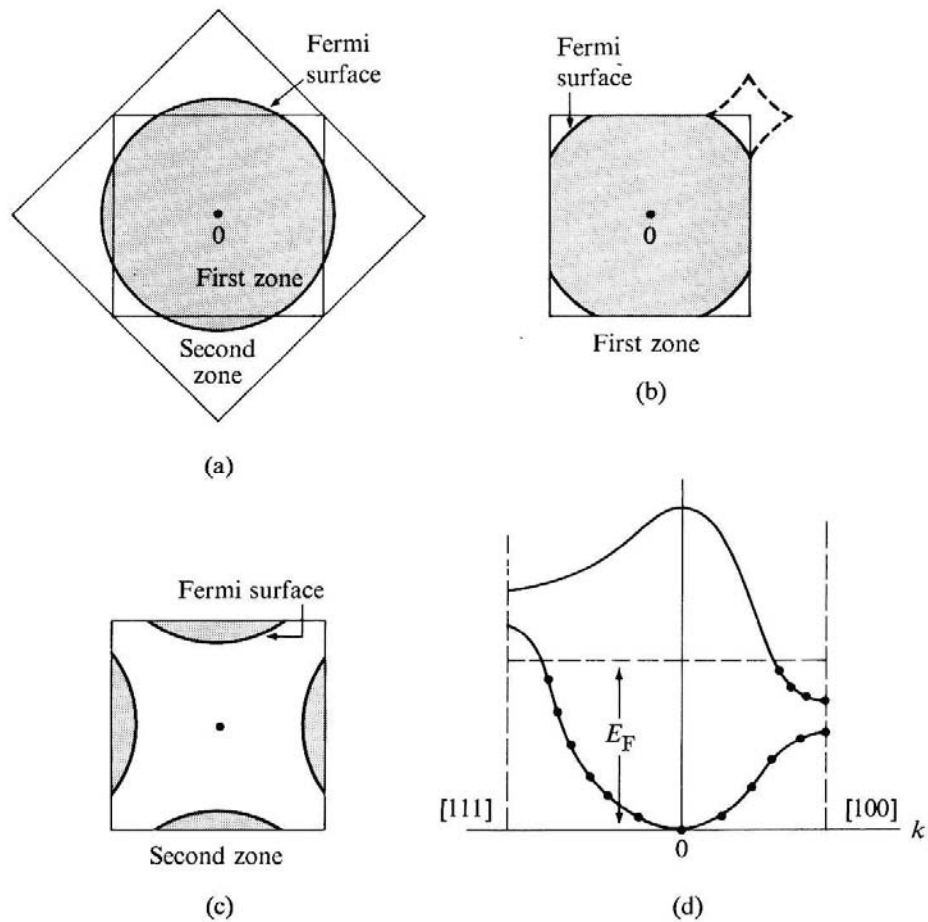

## 5.8 Velocity of The Bloch Electron

Consider an electron in a state  $\psi_{\mathbf{k}}$ , the velocity by which it moves through the crystal should be related to the energy of the state according to;

$$v = \nabla_{\mathbf{k}} \omega(k)$$

But since  $\omega = E / \hbar$ , then

$$v = \frac{1}{\hbar} \nabla_{\mathbf{k}} E(k)$$

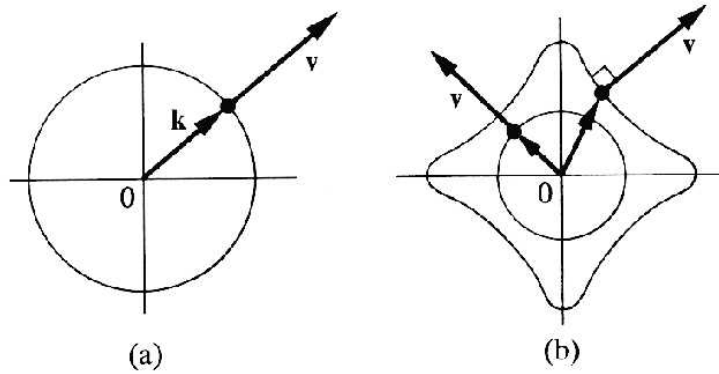

Note:

The velocity  $v$  is constant unless the periodicity of the lattice is changed.

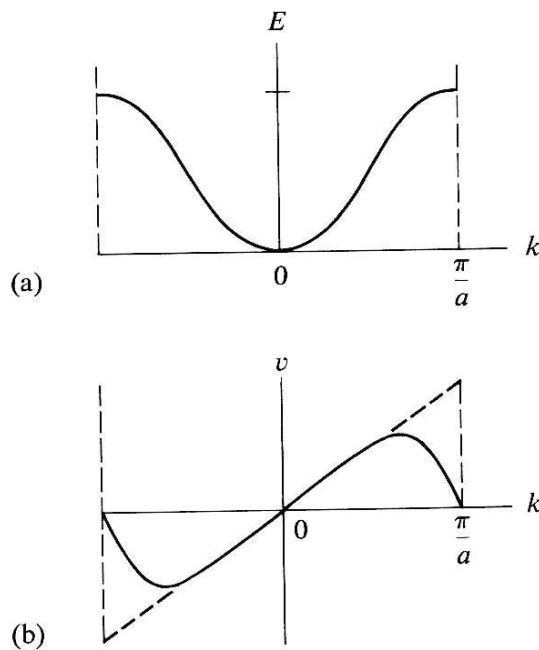

## 5.9 The Effective Mass

When an electric field  $\epsilon$  is applied to a crystal, the Bloch electron will undergo an acceleration  $a$  where;

$$a = \frac{dv}{dt} = \frac{dv}{dk} \frac{dk}{dt} \quad (12)$$

The electric force  $F$  that caused this acceleration is given by,

$$F = \hbar \frac{dk}{dt} \quad (13)$$

Substituting from (11) & (13) into (12) leads to;

$$a = \frac{1}{\hbar^2} \frac{d^2 E}{dk^2} F \quad (14)$$

Eq. (14) has the same form as Newton's second law, hence one can define the electron *effective mass* as,

$$m^* = \hbar^2 / \left( \frac{d^2 E}{dk^2} \right) \quad (15)$$

### Note:

- 1- When the curvature is large the mass is small, and the small curvature indicates a large mass.

- 2- The effective mass  $m^*$  could be (+ve) or (-ve). Near the bottom of the band, the electron *accelerates* and  $m^*$  is *positive*. But as the electron approaches the top of the band it will *decelerate*, and hence  $m^*$  is *negative*.
- 3- the effective mass  $m^*$  is related to the free electron mass  $m_e$  by the following relation:

$$m^* = m_e \frac{F_{ext}}{F_{ext} + F_L}$$

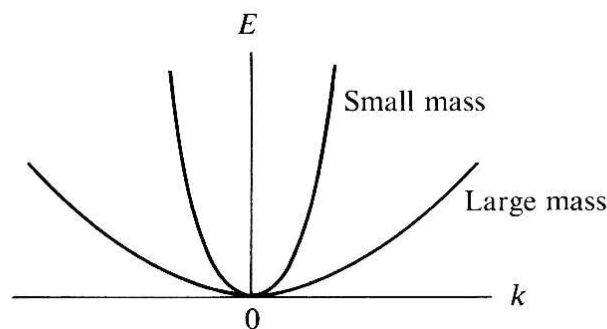

## 5.10 The Electrical conductivity

\* Recall: In the free electron model the electrical conductivity is given by;

$$\sigma = \frac{ne^2\tau_F}{m^*} \quad (16)$$

\* Within the framework of band theory, a corresponding formula can be obtained as following:

- When an external electric field is applied, FS will be shifted a distance  $\delta k$  on the k-space. For 1D;

$$\delta k_x = \frac{F}{\hbar} \delta t = -\frac{e\varepsilon}{\hbar} \delta t = -\frac{e\varepsilon}{\hbar} \tau_F \quad (17)$$

- The current density can be then written as;

$$\begin{aligned} J_x &= -ev_{F,x} g(E_F) \delta E \\ &= -ev_{F,x} g(E_F) \left[ \frac{\partial E}{\partial k_x} \right]_{E_F} \delta k_x \end{aligned} \quad (18)$$

But

$$\frac{\partial E}{\partial k_x} = \hbar v_{F,x} \quad (19)$$

Substituting from (17) & (19) into (18), we get

$$J_x = e^2 v_{F,x}^2 \tau_F g(E_F) \varepsilon$$

If FS is a sphere,  $v_{F,x}^2 = \frac{1}{3} v_F^2$ , hence;

$$J = \frac{1}{3} e^2 v_F^2 \tau_F g(E_F) \varepsilon$$

Therefore  $\sigma$  is;

$$\sigma = \frac{1}{3} e^2 v_F^2 \tau_F g(E_F) \quad (20)$$

In (20) the predominant factor in determining  $\sigma$  is the density of state at FS, and not the electron density  $n$  as (16) states.

In fact (16) is an special case of (20), results when Fermi energy is taken as (10).

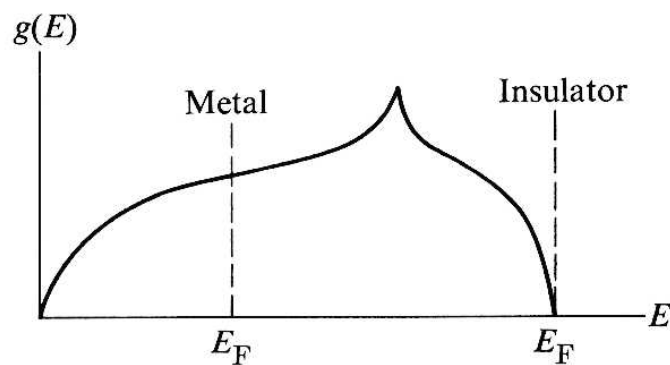

## 5.11 The Hall Effect

**Define:** a *hole* as one vacant state occurs in a totally full band.

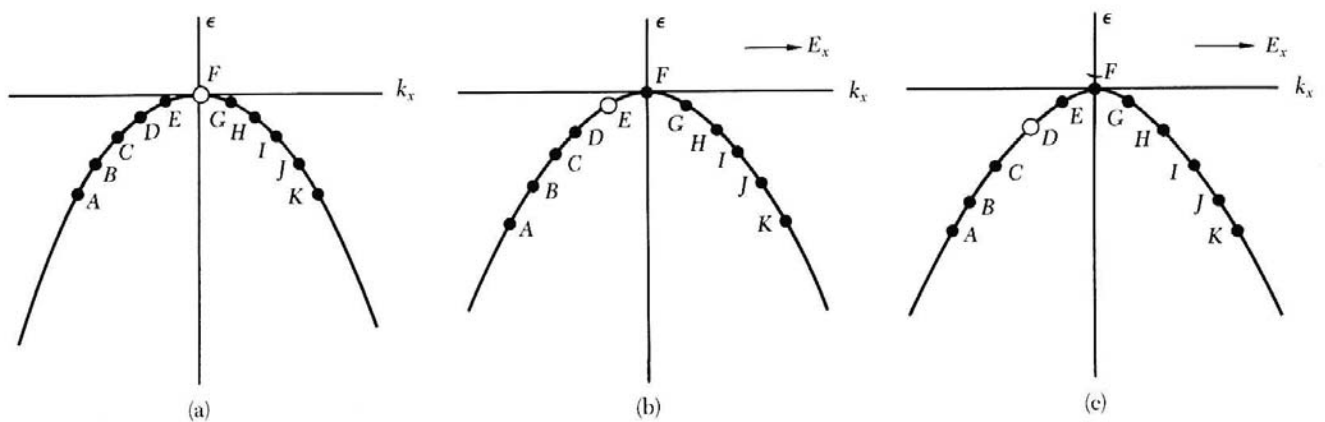

- \* When two bands overlap with each other, electrons will exist in the upper band and holes in lower.
- \* The Hall constant expression for a metal contains both electrons and holes is;

$$R = \frac{R_e \sigma_e^2 + R_h \sigma_h^2}{(\sigma_e + \sigma_h)^2} \quad (21)$$

where  $R_h$  is the hole Hall constant given by,

$$R_h = \frac{1}{n_h e} \quad (22)$$

The total Hall constant  $R$  may be (-ve) or (+ve) depending on whether the contribution of the electrons or the holes dominates.

## Intrinsic Semiconductors

### *Intrinsic Semiconductors* :

- The substance is pure, and hence the carrier concentration is an *intrinsic* property.
- The substance conducts current by both carriers electrons and holes.
- The concentration of electrons and the concentration of holes are equal  $\sim 10^{15}/\text{cm}^3$ .

$$n = p = 2 \left( \frac{kT}{2\pi\hbar^2} \right)^{3/2} (m_e m_h)^{3/4} e^{-E_g/2kT} \quad (1)$$

Or,

$$n = p \propto e^{-E_g/2kT} \quad (2)$$

- The Fermi level lies at the middle of the energy gap, i.e.

$$E_F \sim 1/2 E_g \quad (3)$$



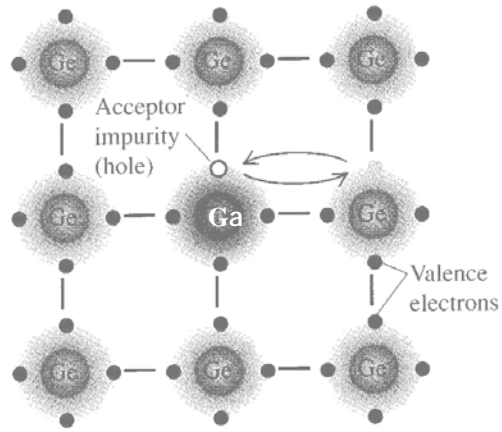

(a)

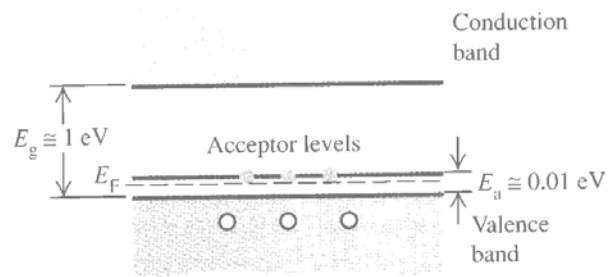

(b)

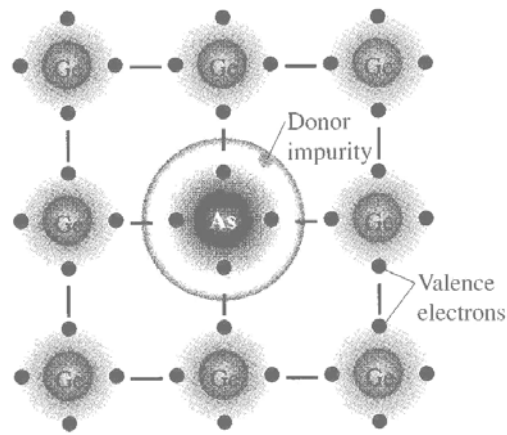

(a)

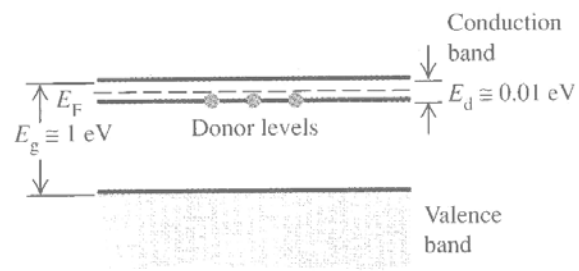

(b)

### *Extrinsic Semiconductors :*

- The substance contains a large number of impurities which supply most of the carriers. Hence the carrier concentration is an *extrinsic* property.
- The substance conducts current only by one type of carriers: electrons or holes.
- The carrier concentration is about  $\sim 10^{15}/\text{cm}^3$ . But by heavy *doping* one can get sample with concentration of  $10^{18}/\text{cm}^3$ .
- When a tetravalent sample (Si) is *doped* by a pentavalent atoms (As), each impurity atom will contribute *an electron* to the CB. Because of that these impurities are called *donors* and the substance is known as *n-type Semiconductor*.
- When a tetravalent sample (Si) is *doped* by a trivalent atoms (Ga), each impurity atom will contribute *a hole* to the VB. Because of that these impurities are called *acceptors* and the substance is known as *p-type Semiconductor*.

## Semiconductors Statistics

To find the carrier concentration in a semiconductor contain both donors and acceptors, it is easily to divide the substance into two regions:

### *Intrinsic region* :

- The concentration of electrons equals to the concentration of holes equals to what called *the intrinsic concentration*  $n_i$  ;

$$n = p = n_i = 2 \left( \frac{kT}{2\pi\hbar^2} \right)^{3/2} (m_e m_h)^{3/4} e^{-E_g/2kT} \quad (4)$$

- This region obtains when the impurity doping is so small, i.e.

$$n_i \gg (N_d - N_a) \quad (5)$$

where  $N_d$ ,  $N_a$  are the concentration of donors and acceptors respectively.

- Since  $n_i \propto e^{-E_g/2kT}$  all semiconductors become intrinsic at high temperatures .

### *Extrinsic region :*

- Using the common doping rate  $\sim 10^{15}/\text{cm}^3$ , the condition (4) is not satisfied, and the number of carriers supplied by impurities at 300K is large enough to change the *intrinsic concentration*  $n_i$ .
- In this case :

$$np = n_i^2 \quad (6)$$

- When  $N_d \gg N_a$  (*n-type Semiconductor*);

And

$$\begin{aligned} n &= N_d \\ p &= \frac{n_i^2}{N_d} \end{aligned} \quad (7)$$

- When  $N_a \gg N_d$  (*p-type Semiconductor*);

and

$$\begin{aligned} p &= N_a \\ n &= \frac{n_i^2}{N_a} \end{aligned} \quad (8)$$

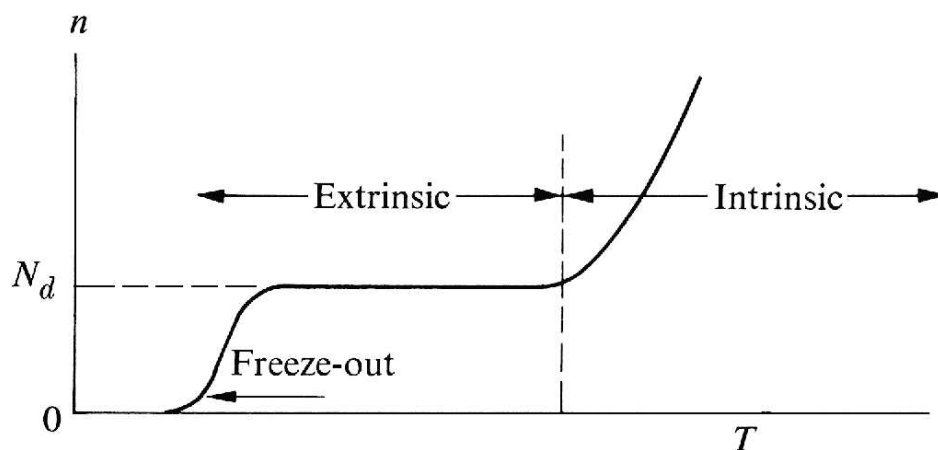

## Electrical Conductivity and Mobility

\* Assume an n-type semiconductor, using the free electron model the electrical conductivity is given by;

$$\sigma_e = \frac{ne^2\tau_e}{m_e} \quad (9)$$

\* In semiconductors, transport characteristic is often described by *mobility*, the ratio between the electron velocity and the applied field  $\mu = v_d / \mathcal{E}$

$$\mu_e = \frac{e\tau_e}{m_e} \quad (10)$$

One can express the electrical conductivity in terms of mobility as;

$$\sigma_e = ne\mu_e \quad (11)$$

A typical value may be obtained by substituting

$$\sigma_e = 1 \text{ } (\Omega.m)^{-1} \quad , \text{ and } n = 10^{21} m^{-3}$$

Then

$$\mu_e \approx 10^{-2} m^2 / V.s = 100 cm^2 / V.s$$

\* Total conductivity in a sample contains both carriers is

$$\sigma = ne\mu_e + ne\mu_h \quad (12)$$

## Temperature dependence of Conductivity:

### 1- A semiconductor in the intrinsic region:

Its conductivity is expressed by (12). But in this situation the concentration  $n$  increases exponentially with temperature, thus;

$$\sigma = f(T)e^{-E_g/2KT} \quad (13)$$

where  $f(T)$  is a function which depends only weakly on the temperature (The function depends on the mobilities and effective masses of the particles.)

If one takes the logarithms of both sides of the equation, he will get;

$$\log \sigma = \text{Cons.} - \frac{E_g}{2KT}$$

A plot of  $\log \sigma$  versus  $1/T$  should give a straight line with a slope of  $(-E_g/2k)$  that determines *the energy gap* of the material.

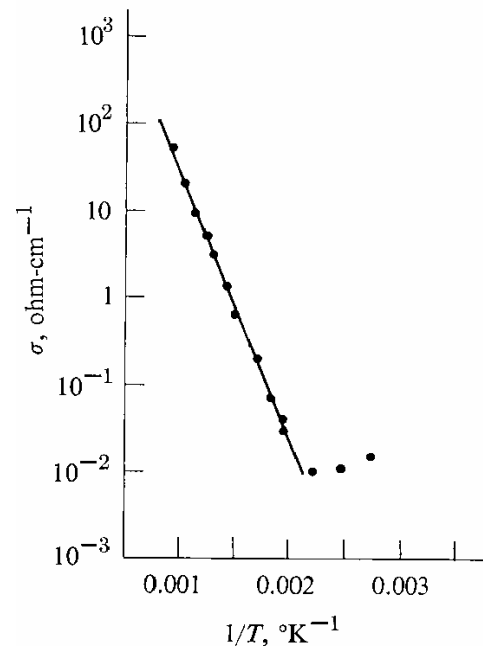

### 2- A semiconductor in the extrinsic region:

In that case the temperature dependence of  $\sigma$  on  $T$  is not usually as strong as indicated above. Suppose that the substance is *extrinsic n-type*. The conductivity is

$$\sigma_e = ne\mu_e$$

But the electron concentration  $n$  is now a constant equal to  $N_d$ , the donor concentration. And any temperature dependence present must be *due to the mobility of electrons*.

### Temperature dependence of Mobility:

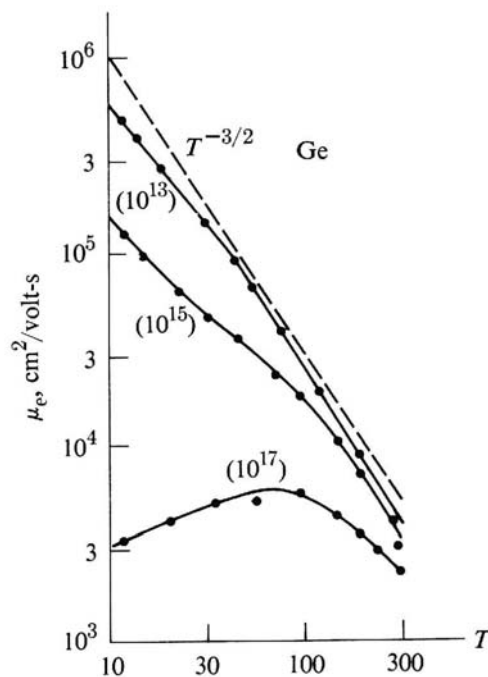

$$\mu_e \propto T^{-3/2}$$

### Hall Effect in Semiconductors

\* The Hall constant expression for a semiconductor contains both electrons and holes is;

$$R = \frac{R_e \sigma_e^2 + R_h \sigma_h^2}{(\sigma_e + \sigma_h)^2}$$

or

$$R = \frac{p\mu_h^2 - n\mu_e^2}{e(n\mu_e + p\mu_h)^2} \quad (13)$$

The total Hall constant  $R$  may be (-ve) or (+ve) depending on whether the contribution of the electrons or the holes dominates. It may vanish in semiconductors that reflect a high degree of symmetry.

## Direct and Indirect-Gap Semiconductors

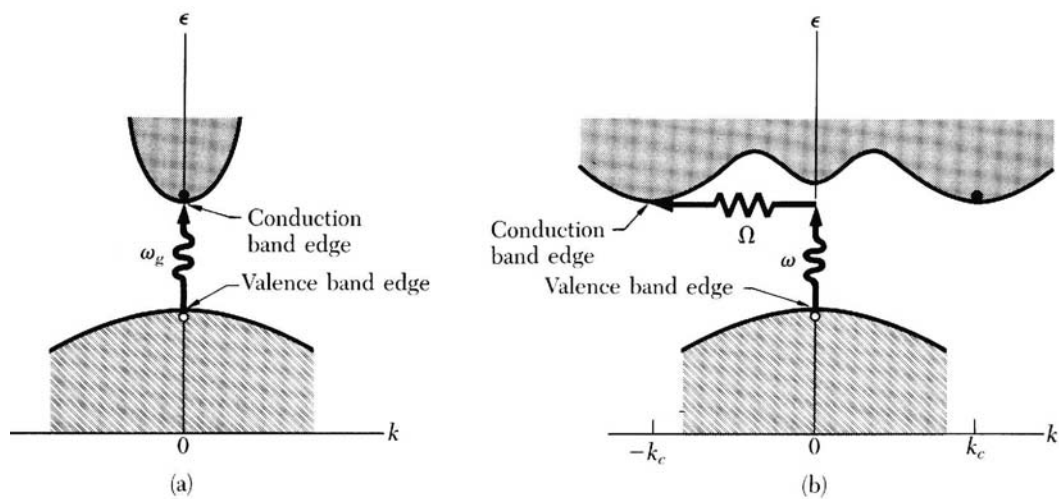



## The Fundamental Absorption:

In fundamental absorption, an electron absorbs a photon (from the incident beam), and jumps from the valence into the conduction band. The photon energy must be equal to the energy gap, or larger. Therefore, the frequency must be

$$\nu \geq (E_g/h)$$

The frequency  $\nu_0 = E_g/h$  is referred to as *the absorption edge*.

In the photon absorption process, the total energy and momentum of the electron-photon system must be conserved. Therefore

$$E_f = E_i + h\nu$$

$$k_f = k_i + q$$

However, since the wave vector of the photon  $q$  is negligibly small. Thus, the momentum condition reduces to

$$k_f = k_i$$

This selection rule means that only vertical transitions in k-space are allowed between the valence and conduction bands.

## For Direct-Gap Semiconductors:

*the absorption coefficient* has the form

$$\alpha_d = A(h\nu - E_g)^{1/2}$$

where  $A$  is a constant involving the properties of the bands.

A useful application of these results is their use in measuring energy gaps in semiconductors.

Thus  $E_g$  is directly related to the frequency edge,  $E_g = h\nu_0$ .

This is now the standard procedure for determining the gap, because of its accuracy and convenience.

Since the energy gaps in semiconductors are small (1 eV or less) *the fundamental edge* usually occurs in the *infrared* region.

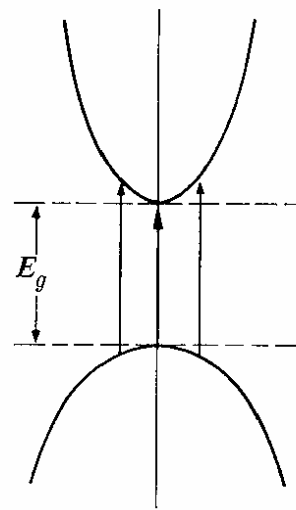

## For Indirect-Gap Semiconductors:

In this case, the electron cannot make a direct transition from the top of the valence band to the bottom of the conduction band because this would violate the momentum selection rule.

Such a transition may still take place, but as a two-step process. The electron absorbs both a photon and a phonon simultaneously. The photon supplies the needed energy, while the phonon supplies the required momentum.

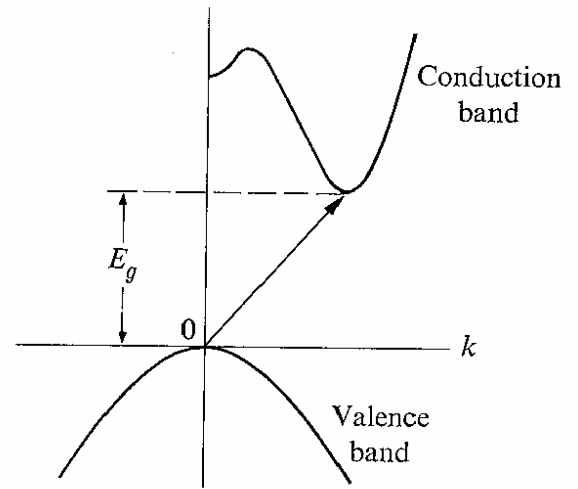

*The absorption coefficient* in this case has the form

$$\alpha_i = A'(T)(h\nu - E_g)^2$$

where  $A'(T)$  is a constant depends on temperature due to the phonon contribution to the process.

Note that  $\alpha_i$  increases as the second power of  $(h\nu - E_g)$ , much faster than the half-power of this energy difference, as in the direct transition. So we may use the optical method to discriminate between direct- and indirect-gap semiconductors.

# The Gunn Effect

## Hot electrons:

At high electric fields electrons gain more energy and, their temperature  $T_e$  may be higher than the lattice temperature  $T_L$ , i.e. the electrons become “hot”.

## Gunn effect:

Deviation of the linear relation between  $\epsilon$  and  $J$  at high electric fields to an oscillatory one known as *Gunn effect*.

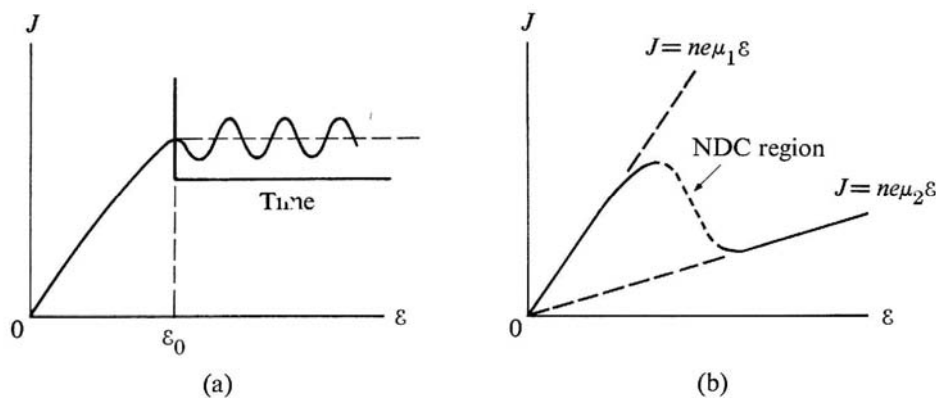

\* to explain this we have to consider the band structure of the semiconductors that show such phenomena. eg. GaAs:

$$\Delta E = 0.36 \text{ eV}$$

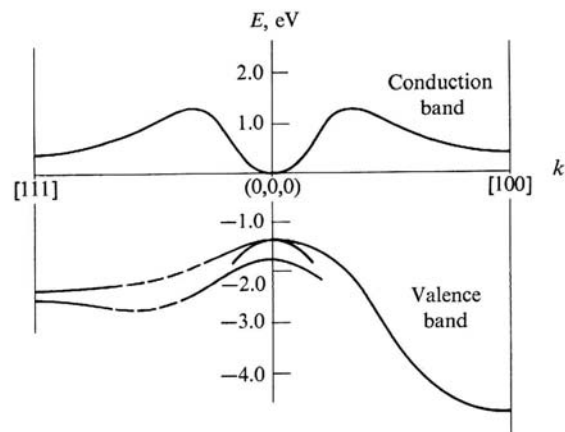

\* Under normal situations, all electrons move to the central valley, and

$$J = n_1 e \mu_1 \varepsilon$$

\* When a strong electric field is applied, electrons will be “hot” , and start to populate the secondary valley, hence,

$$J = n_1 e \mu_1 \varepsilon + n_2 e \mu_2 \varepsilon$$

\* Since the effective mass of valley 2 is much larger than that of valley 1 ( $m_2 = 5 m_1$ ), the mobility in valley 2 is very small ( $\mu_2 = \mu_1 / 50$  ). Because of this small mobility of the secondary valley, the increase in  $J_2$  is much smaller than the sharp decrease in  $J_1$ . And as a result the total current actually decreases.

## 10. Superconductivity

- **A superconductor:** is a material that has zero electrical resistance when cooled below a particular transition temperature known as *the critical temperature* ( $T_c$ ).
- This zero resistivity (or infinite conductivity) is called **Superconductivity**.

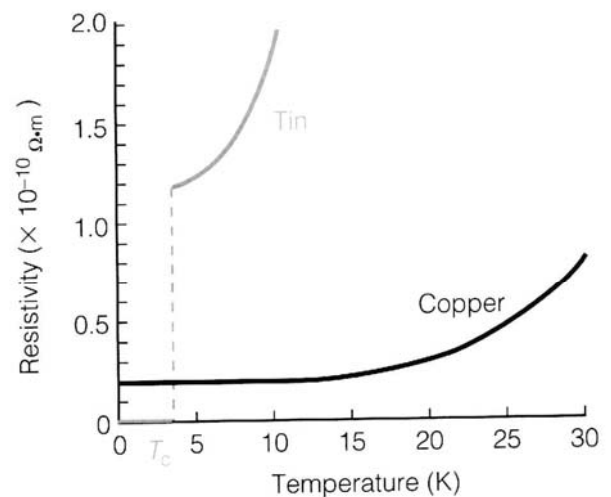
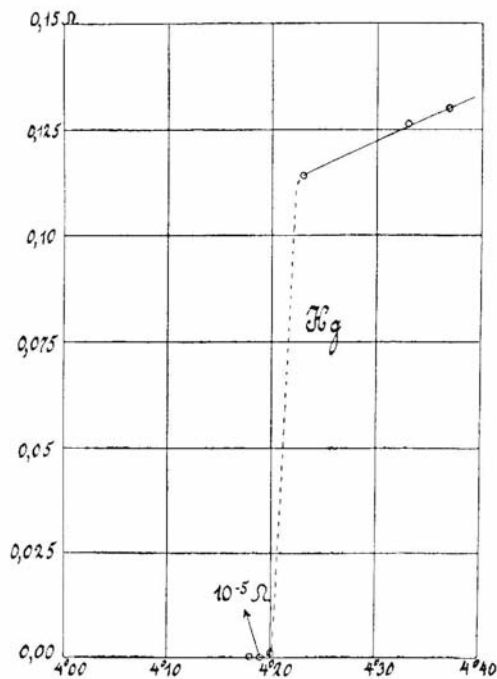

- **Main characteristics:**

1- **Zero resistance:** Under particular values of the magnetic field ( $B_c$ ) and the current density ( $J_c$ ), the superconductor material show a zero resistance.

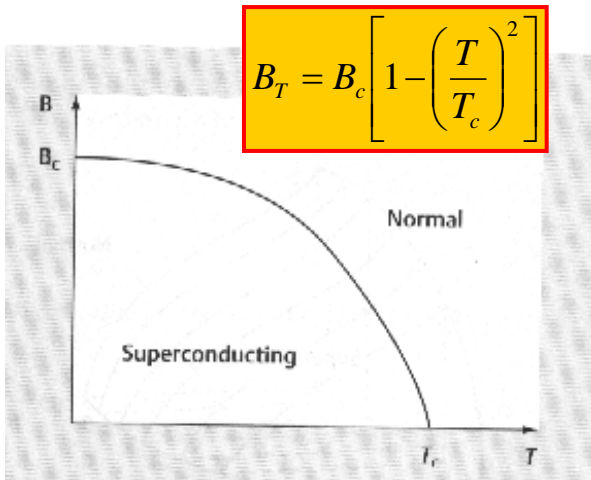

Type I superconductor

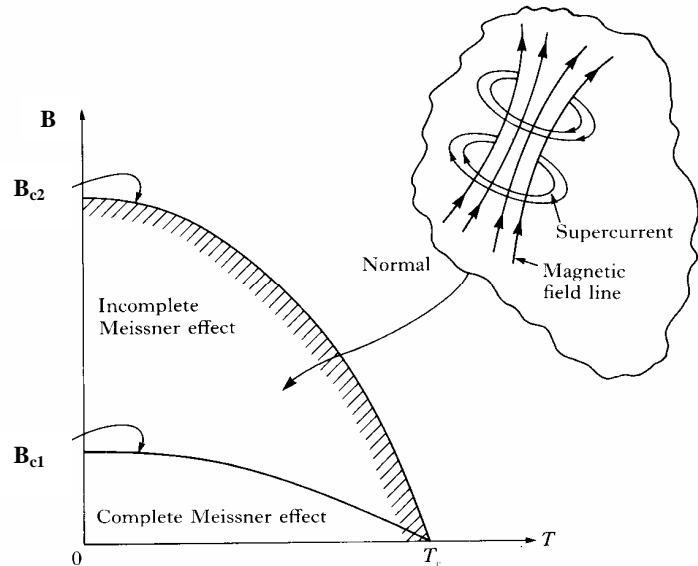

Type II superconductor

2- Meissner effect : superconductors expel magnetic flux such that  $B = 0$  inside.

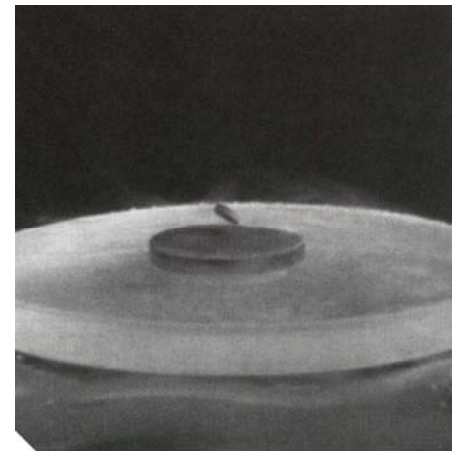
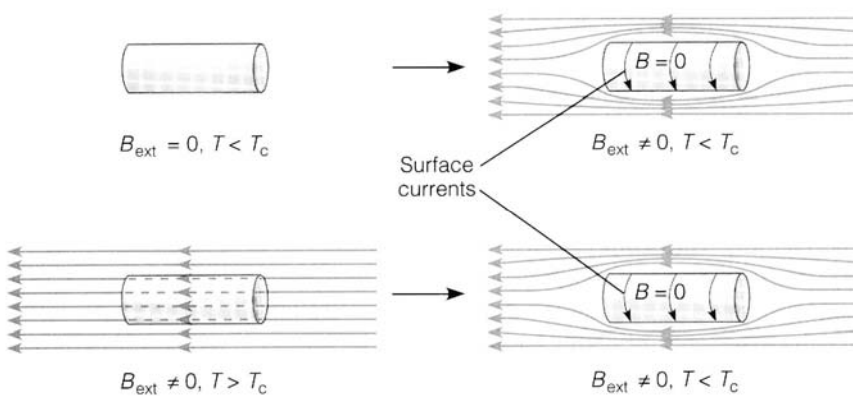

**Important Notes:**

1- Good conductors at RT do not superconduct at low temp.

2-  $T_c$  of two different isotopes are found to be proportional to  $M^{-1/2}$ . where M is the atomic mass.

## What are Cooper pairs?

Below  $T_c$  electrons form pairs mediated by phonons known as *Cooper pairs*.

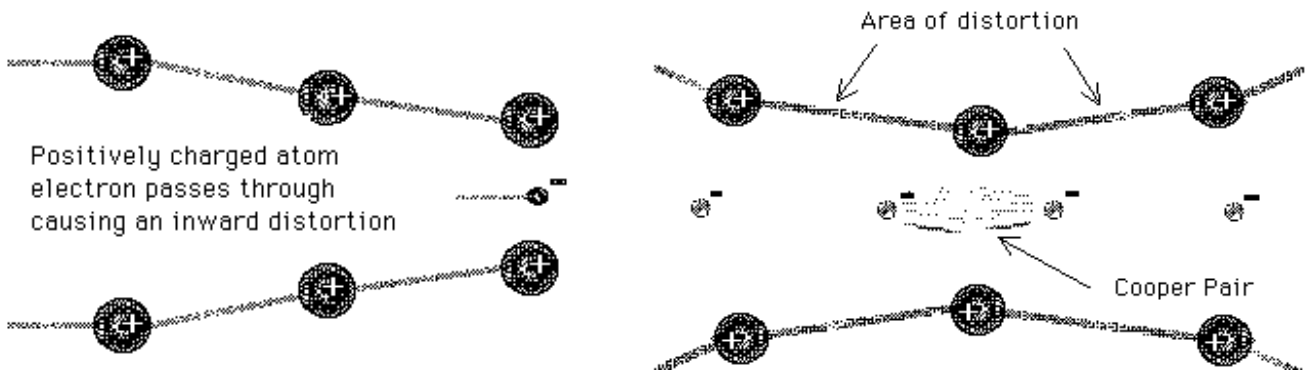

## BCS theory:

Pairs of electrons can behave very differently from single electrons which are **fermions** and must obey the **Pauli exclusion principle**. The pairs of electrons act more like **bosons** which can condense into the same energy level. The electron pairs have a slightly lower energy and leave an energy gap above them on the order of .001 eV which inhibits the kind of collisions which lead to ordinary **resistivity**.

For temperatures such that the **thermal energy** is less than the band gap, the material shows zero resistivity.

Bardeen, Cooper, and Schrieffer received the Nobel Prize in 1972 for the development of the theory of superconductivity.

## Simple picture:

- when two electrons pass near an ion, both are attracted to the ion, leading to an effective attraction between the electrons.
- Above  $T_c$ , Cooper pairs are easily destroyed by thermal energy of the electrons, but below  $T_c$ , Cooper pairs are stable.



- Zero resistance arise because Cooper pairs cannot be scattered by the normal scattering mechanisms in a metal.

### High $T_c$ superconductors:

- Typical value of  $T_c \sim \text{mK} - \text{several K}$ .
- New class of superconductors discovered in 1986, which have considerable higher  $T_c \sim 30 - 138\text{K}$ .

### Applications

- \* Transmission cables that carry current without energy losses will increase the capacity of the transmission system, saving money, space, and energy.
- \* Motors and Generators made with superconducting wires will be smaller and more efficient
- \* Magnetic resonance imaging (MRI) machines enhance medical diagnostics by imaging internal organs. MRI s, which currently are made with low-temperature superconductors, will be smaller and less expensive when made with HTS.
- \* Maglev trains seem to float on air as a result of using superconducting magnets. The newest prototype may exceed **547 Km/hr**.

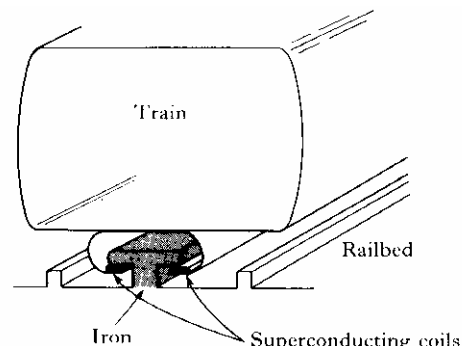
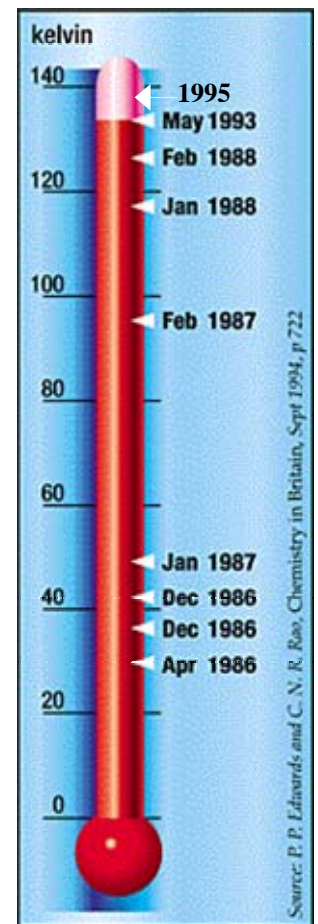

## Superconducting magnets

The simplest, and perhaps most clear, application is to use the supercurrent to generate an intense **magnetic field**.

○ Let us first consider an electromagnet made from a normal metal wire. The magnetic field produced by a long solenoid is given by

$$B = \mu_0 n I$$

where  $n$  is the number of turns per unit length and  $I$  is the current in the wire.

○ **For example**, the maximum current density for **copper** is  $400 \text{ A cm}^{-2}$ . Thus, an electromagnet formed by winding 150 turns per meter using copper wire of diameter 3 mm will give maximum current equals to:

$$I_{max} = J_{max} \pi r^2 = (400 \times 10^4 \text{ A m}^{-2})(3.14)(1.5 \times 10^{-3} \text{ m})^2 = 28.3 \text{ A}$$

Such current will produce maximum field of;

$$B_{max} = \mu_0 n I_{max} = 5.34 \times 10^{-3} \text{ T}$$

This is too small for most practical applications. However, by **placing an iron core** within the solenoid, this magnetic field can be enhanced to about **2T**. The

main disadvantage of this arrangement is that the iron core is extremely **heavy** and **uncomfortable**.

**Let us now consider a similar structure using a *superconducting wire*.**

○ In this case the maximum current is determined by the ***critical current density***. Since it is common to achieve critical current densities of  $10^7 \text{ A cm}^{-2}$ , it is possible to produce very large magnetic fields (of few hundred tesla) with a superconducting solenoid.

○ An additional advantage is that **no iron core** is required in this case. This dramatically reduces the size and weight of the electromagnet and so opens up a whole new range of applications which cannot be performed using large and heavy conventional electromagnets.

### **SQUID magnetometers:**

**SQUID** is an acronym for (**S**uperconducting **Q**uantum **I**nterference **D**evice) magnetometer which is capable of measuring extremely small magnetic fields. It has already found applications in such various areas as **medicine** (measuring the small magnetic fields produced by activity in the brain), **geology** (detecting changes in the Earth's magnetic field due to the presence of oil or other mineral deposits) and **particle physics** (searching for quarks and other exotic particles).